



Location de sanitaires
Mobile toilet hire

CATALOGUE

Location

Collection 2026

2026 Rental Collection Catalog



Marseille · Provence | Paris · Île-de-France | Toulouse · Occitanie | Bordeaux · Nouvelle-Aquitaine



le PETIT
COIN 
EVENTS

SOMMAIRE

INDEX



I Un coin d'exception

An exceptional space

[Présentation](#) *Introduction*

[Notre vision](#) *Our Vision*

[Nos partenaires](#) *Our partners*

[Look Book](#) *Look Book*

II Pourquoi nous choisir ?

Why choose us ?

[Particuliers](#) *Private Clients*

[Professionnels](#) *Professionals*

III Notre gamme

Our collection

[Cabine 1+1 classique](#) *1+1 Standard Cabin*

[Cabine 1+1 premium](#) *1+1 Premium Cabin*

[Cabine 2+1](#) *2+1 Cabin*

[Cabine PMR](#) *PMR Cabin*

[Cabine 3+1](#) *3+1 Cabin*

IV Services & Options

Services and options

[Votre installation](#) *Your Installation*

[Services additionnels](#) *Additional services*

V À vos côtés

By your side

[Nos engagements](#) *Our Commitments*

[Où nous trouver](#) *Where to find us*



I

Un coin d'exception

An exceptional space

Présentation

Introduction

En 2019, David, Florent, Baptiste et Nicolas ont créé Le Petit Coin Events avec une idée simple : proposer des sanitaires mobiles autonomes haut de gamme, avec le même niveau d'exigence que celui que vous pourriez attendre de n'importe quel prestataire événementiel.

Le constat est clair : lors d'un mariage, une réception privée ou un rassemblement corporate, le sanitaire est un choix crucial. Confort, propreté et discrétion sont les maîtres mots pour un événement réussi et sans accroc. Le respect de vos invités est essentiel. Ainsi Le Petit Coin Events répond à cet enjeu avec ses unités dernière génération et autonomes. Conçues comme de vrais espaces et pensées pour être installées sur tous types de terrain et en toute saison.

Nos sanitaires mobiles aux finitions soignées garantissent une fabrication 100 % française. Nos collaborateurs sur place sont formés aux règles d'hygiène et maîtrisent une logistique spécifique. Vous pouvez faire confiance à une équipe technique et commerciale motivée et consciencieuse. Opter pour Le Petit Coin Events est la garantie d'une expérience fiable et sereine, de la prise de contact à la fin de votre événement. Le respect de votre lieu de réception et de l'environnement fait partie intégrante de notre exigence, sans compromis sur la qualité de service.

Depuis 2019, particuliers, professionnels et collectivités, sécurisent leurs prestations, en collaborant avec notre structure et adhèrent à notre vision.

In 2019, David, Florent, Baptiste and Nicolas founded Le Petit Coin Events with a simple idea: to provide high end self contained mobile toilet units, delivered with the same level of standards you would expect from any top tier supplier.

One thing is clear : at a wedding, a private reception or a corporate gathering, restrooms are a crucial decision. Comfort, cleanliness and discretion are the key ingredients for an event that runs smoothly. Respecting your guests matters. That is why Le Petit Coin Events meets this need with its latest generation autonomous units, designed as true interior spaces and built to be installed on any type of ground, in any season.

Our mobile units feature refined finishes and are 100 percent made in France. On site staff are trained in hygiene protocols and understand the specific logistics these installations require. You can rely on a committed, conscientious technical and commercial team. Choosing Le Petit Coin Events means a dependable, stress free experience, from first contact through to the end of your event. Respect for your venue and the environment is central to our standards, with no compromise on service quality.

Since 2019, private clients, businesses and local authorities have secured their events by working with our team and sharing our vision.

[Revenir au sommaire](#)
Return to contents

Florent CATALUNA
Responsable technique & commercial
Technical and sales manager



Nicolas SARKISSIAN
Responsable technique & commercial
Technical and sales manager

David ISTAS
Associé
Partner



Baptiste GALLAND
Associé
Partner

Notre vision

Our vision

Votre partenaire sanitaire depuis 2019

Your sanitary partner since 2019

Le Petit Coin Events vous propose des sanitaires de dernière génération. Notre expertise vous garantit une logistique parfaitement maîtrisée et des solutions personnalisées, adaptées à chaque lieu d'implantation.

Notre service clé en main, vous permet de bénéficier du confort domestique où que vous soyez et par tous les temps. Notre gamme se décline en cinq modèles qui conviendra favorablement à votre nombre d'invités, ainsi qu'à la durée d'utilisation.

Notre équipe commerciale est à votre écoute pour échanger et adapter notre offre à vos besoins.

Le Petit Coin Events provides latest generation mobile toilets. Our expertise ensures fully controlled logistics and tailored solutions, adapted to each site and set up.

Our turnkey service gives you domestic level comfort wherever you are, in any weather. Our range includes five models designed to match your guest numbers and the number of days you need them.

Our commercial team is available to discuss your requirements and adapt our offer to your budget and logistical constraints.



Une fabrication made in France

Made in France manufacturing

Fabriqués en France, nos véhicules sanitaires se distinguent par leur design innovant et sont conçus à partir de matériaux de grande qualité et de dernière génération.

Crafted in France, our sanitary vehicles stand out for their innovative design and are built using high-quality, state-of-the-art materials.



Un partenaire

A trusted partner

Choisir Le Petit Coin Events, c'est opter pour un partenaire qui respecte à la fois votre budget et les contraintes logistiques de votre lieu d'installation.

Choosing Le Petit Coin Events means partnering with a team that respects both your budget and the logistical constraints of your venue.



Service clé en main

Turnkey service

Nous nous occupons de tout, de A à Z et garantissons une maîtrise totale du processus d'installation, de la mise en place jusqu'au retrait.

We take care of everything from A to Z, ensuring full control of the entire process, from set up through to removal.



Nos engagements

Our commitments

Nos engagements se reflètent à travers quatre mots-clés : autonomie, discrétion, écologie et une hygiène irréprochable.

Our commitments are defined by four key values: autonomy, discretion, sustainability, and impeccable hygiene..

[Revenir au sommaire](#)

Return to contents

[Revenir au sommaire](#)
Return to contents

Nos partenaires

Our partners

Nous collaborons avec des acteurs prestigieux et de confiance, partageant la même vision et la même exigence. Être à vos côtés depuis tant d'années nous permet de maintenir cette rigueur qui a fait notre réputation.

We work with prestigious, trusted partners who share the same vision and standards. Being by your side for so many years has allowed us to maintain the rigour that has built our reputation.

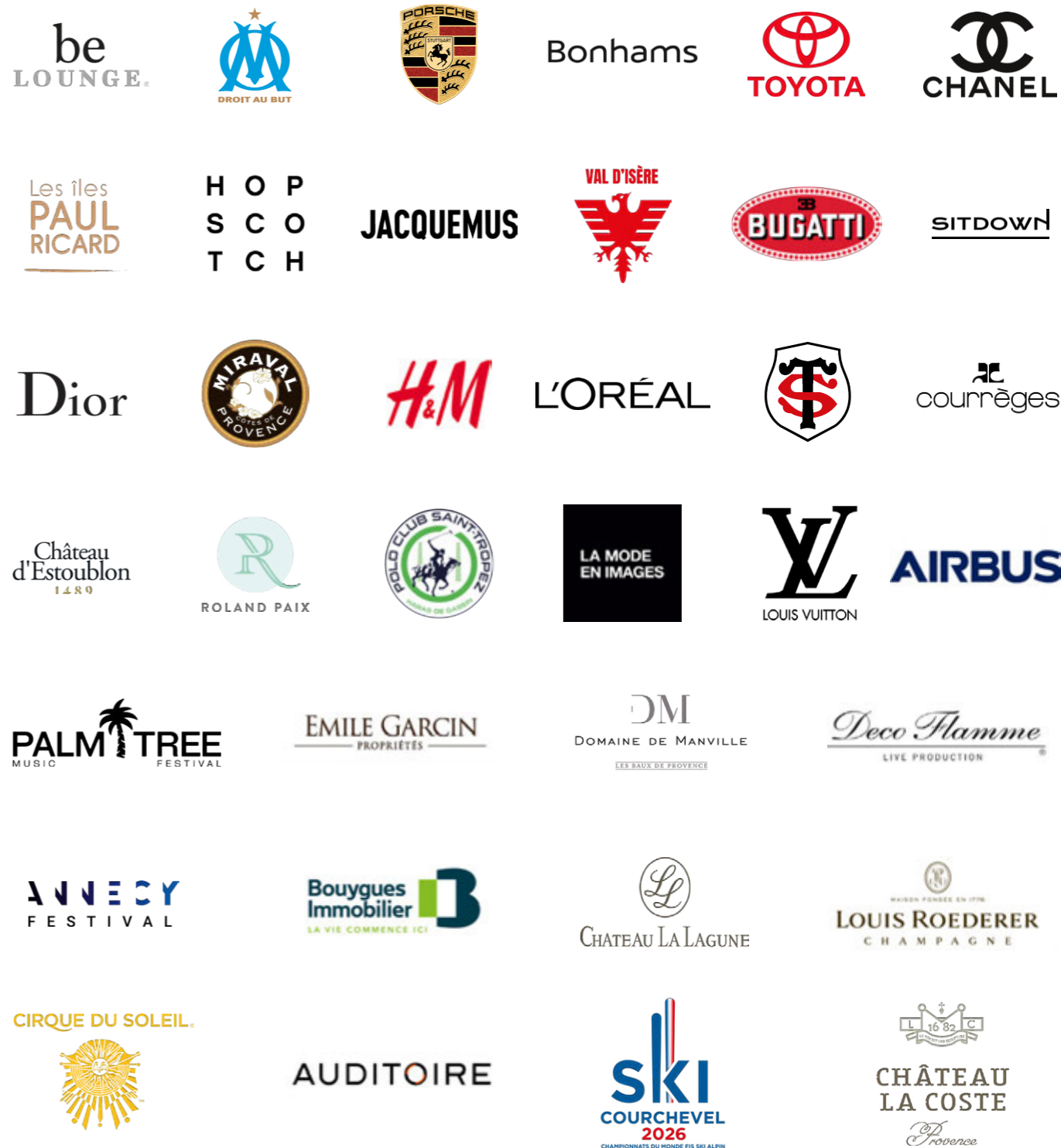

LOOK BOOK





















III

Pourquoi nous choisir ? *Why choose us ?*

Particuliers

Private clients

Le confort discret des grandes occasions

Discreet comfort for exceptional occasions

Parce que recevoir chez soi, dans un jardin ou sur un lieu d'exception demande un haut niveau d'exigence, Le Petit Coin Events vous accompagne pour que chaque détail soit à la hauteur de vos attentes.

Mariages, anniversaires, baptêmes, célébrations familiales, réceptions privées ou événements uniques : nos sanitaires autonomes s'intègrent avec élégance dans tous les environnements, du plus champêtre au plus sophistiqué. Nos cabines offrent le confort d'un sanitaire domestique, dans un design sobre et raffiné, avec une discrétion d'installation totale.

Service clé en main, livraison et retrait planifiés en amont, notre équipe s'adapte à votre lieu, à votre planning et à vos envies, tout en respectant l'atmosphère et l'esthétique de votre événement.

Parce que vos invités méritent le meilleur, nous apportons une solution sanitaire alliant fonctionnalité et confort.

Because hosting at home, in a garden or at an exceptional venue calls for the highest standards, Le Petit Coin Events supports you so every detail lives up to your expectations.

Weddings, birthdays, christenings, family celebrations, private receptions or one off events: our self contained toilet units blend seamlessly into any setting, from relaxed countryside scenes to the most refined locations. Each cabin delivers the comfort of a home restroom in a clean, understated design, with a discreet installation and minimal visual impact.

With a turnkey service and delivery and removal scheduled in advance, our team adapts to your venue, your timetable and your plans, while respecting the atmosphere and aesthetic of your event.

Because your guests deserve the best, we provide a restroom solution that combines practicality with genuine comfort.





Professionnels

Professionalss

Renforcer votre image, jusque dans les détails

Reliable service that reflects your brand

Qu'il s'agisse d'un événement d'entreprise, d'un lancement de produit, d'une inauguration, d'un tournage ou d'une opération de communication, nous accompagnons les professionnels avec des solutions sanitaires fiables, soignées et parfaitement intégrées à votre événement.

Nos installations s'adaptent à tous les environnements. En centre ville, en pleine nature ou sur des domaines privés, nos sanitaires offrent à vos équipes, clients ou invités le confort d'un espace pensé pour répondre à vos plus hautes exigences.

Ponctualité, réactivité, discrétion. Notre service clé en main vous permet de vous concentrer sur votre événement : nous nous chargeons du reste, avec précision et efficacité.

Faire appel au Petit Coin Events, c'est garantir une prestation à la hauteur de votre image.

Whether it is a corporate event, a product launch, an opening, a film shoot or a brand activation, we support professionals with restroom solutions that are reliable, well finished and seamlessly integrated into your event.

Our installations adapt to any environment, outdoors, in an urban setting, in the countryside or at a private venue. Our units provide your teams, clients and guests with the comfort of a space designed to meet high end expectations.

Punctual, responsive, discreet. Our turnkey service lets you focus on your event while we take care of the rest, with precision and efficiency.

Choosing Le Petit Coin Events means delivering a service that matches your brand standards.

[Revenir au sommaire](#)

Return to contents



III

Notre gamme

Our collection

Cabine 1+1 classique

1+1 Standard Cabin

[Revenir au sommaire](#)

Return to contents

Description

Description

Longueur	3,90 m	Length	3,90 m
Largeur	2,50 m	Width	2,50 m
Hauteur	2,60 m	Height	2,60 m
Poids total	750 kg	Total weight	750 kg
Capacité	Jusqu'à 100 personnes	Capacity	Up to 100 people

 x 1
 x 1

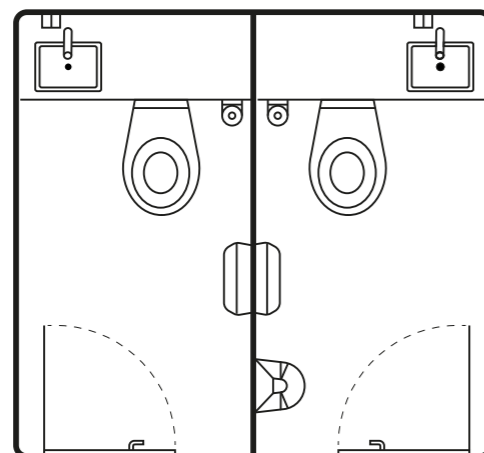

Cabine I+I premium

I+I Premium Cabin

[Revenir au sommaire](#)
Return to contents

Description

Description

Longueur	5,30 m	Length	5,30 m
Largeur	2,50 m	Width	2,50 m
Hauteur	3,00 m	Height	3,00 m
Poids total	1350 kg	Total weight	1350 kg
Capacité	Jusqu'à 150 personnes	Capacity	Up to 150 people

 x 1
 x 1
 x 1

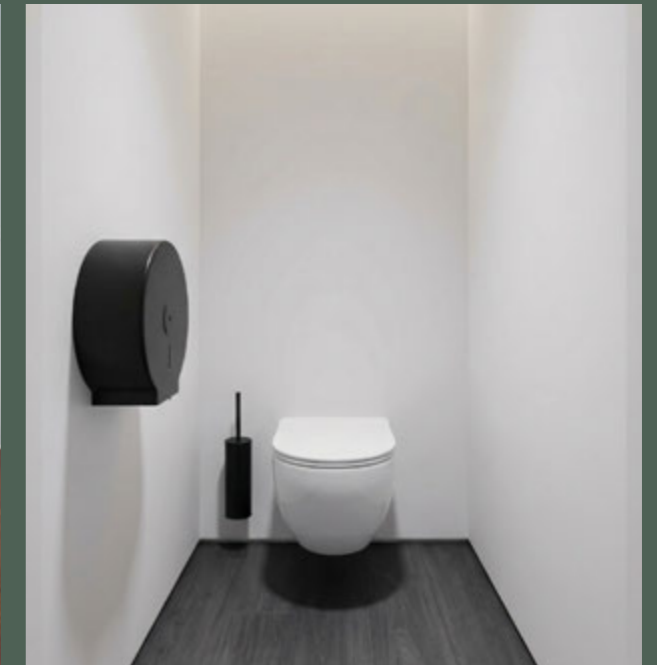
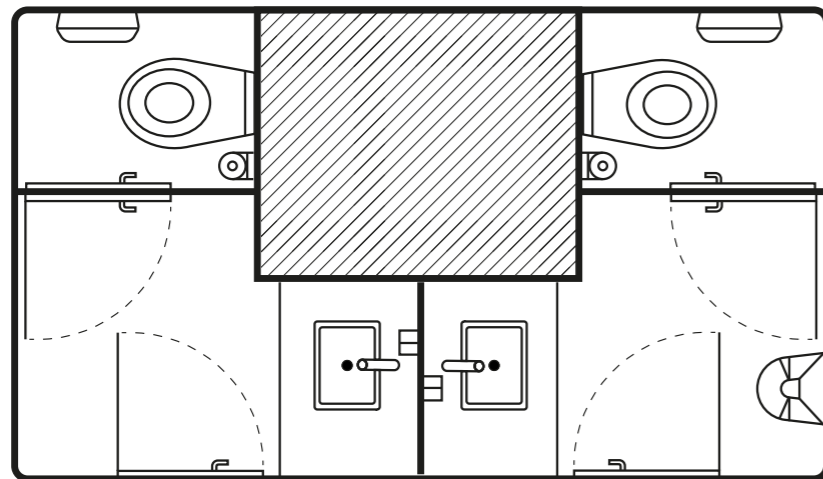

Cabine 2+1

2+1 Cabin

[Revenir au sommaire](#)
Return to contents

Description

Longueur	6,20 m	Length	6,20 m
Largeur	2,40 m	Width	2,40 m
Hauteur	3,00 m	Height	3,00 m
Poids total	2500 kg	Total weight	2500 kg
Capacité	Jusqu'à 250 personnes	Capacity	Up to 250 people

-  x 2
-  x 1
-  x 1
-  x 1

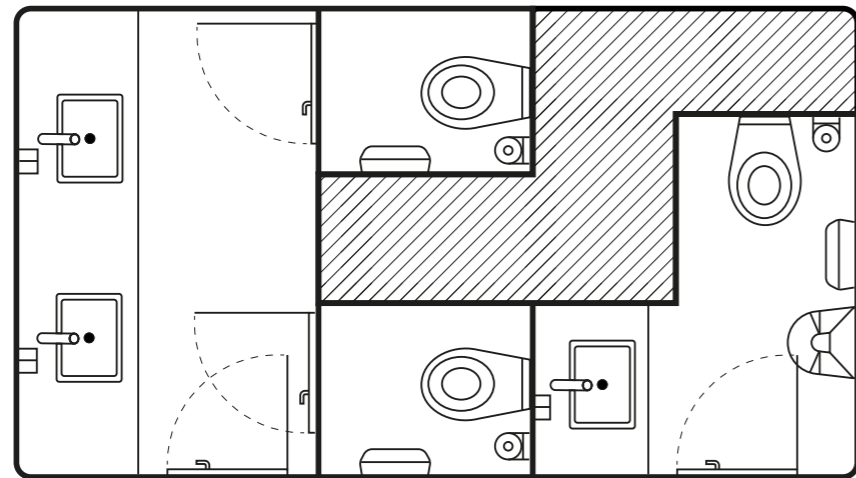

Cabine PMR

PMR Cabin

[Revenir au sommaire](#)
Return to contents

Description

Description

Longueur	8,20 m	Length	8,20 m
Largeur	2,60 m	Width	2,60 m
Hauteur	3,10 m	Height	3,10 m
Poids total	2700 kg	Total weight	2700 kg
Capacité	Jusqu'à 250 personnes	Capacity	Up to 250 people

 x1
  x1
 x1
  x1
 x1

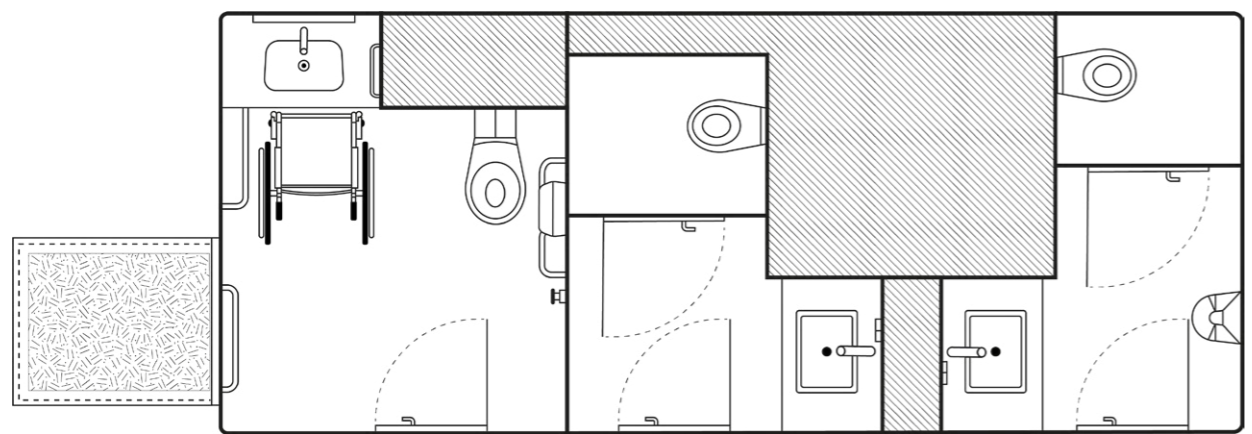

Cabine 3+1

3+1 Cabin

[Revenir au sommaire](#)
Return to contents

Description

Description

Longueur	8,20 m	Length	8,20 m
Largeur	2,60 m	Width	2,60 m
Hauteur	3,10 m	Height	3,10 m
Poids total	3200 kg	Total weight	3200 kg
Capacité	Jusqu'à 500 personnes	Capacity	Up to 500 people

-  x 3
-  x 1
-  x 3
-  x 1

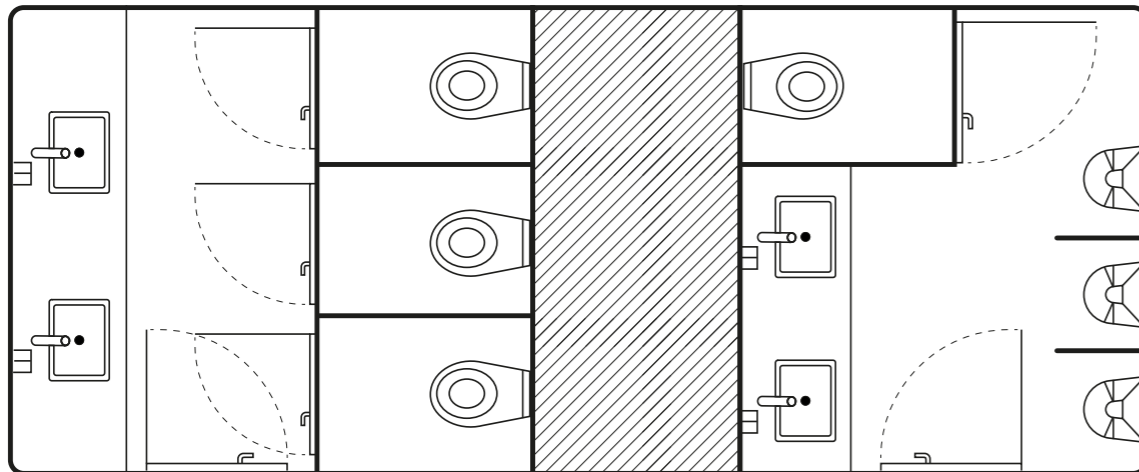



IV

Services & Options

Services & Options

Votre installation

Your installation

1^{ère} étape First step

Choisissez votre véhicule sanitaire
Choose your sanitary vehicle

[Revenir au sommaire](#)
Return to contents

Tous nos prix sont exprimés en HT. *All prices are quoted excluding VAT.*



Cabine 1+1 classique
1+1 classique cabin



Jusqu'à 100 personnes
Up to 100 people

995 €



Cabine 1+1 premium
1+1 premium cabin



Jusqu'à 150 personnes
Up to 150 people

1295 €



Cabine 2+1
2+1 cabin



Jusqu'à 250 personnes
Up to 250 people

1795 €



Cabine PMR
PMR cabin



Jusqu'à 250 personnes
Up to xx people

1995 €



Cabine 3+1
3+1 cabin



Jusqu'à 500 personnes
Up to 500 people

2795 €

2^{ème} étape Second step

Choisissez votre cuve de récupération
Choose your waste recovery tank

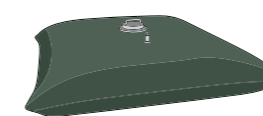

Cuve 1
Waste tank 1

Jusqu'à 70 personnes
Up to 70 people

195 €

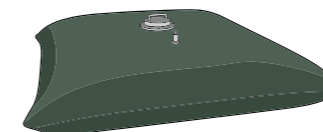

Cuve 2
Waste tank 2

Entre 70 et 250 personnes
Between 70 and 250 people

295 €

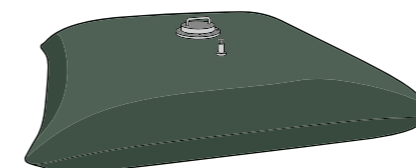

Cuve 3
Waste tank 3

250 personnes et +
250 people and more

395 €

3^{ème} étape Third step

Livraison & reprise
Delivery & pickup

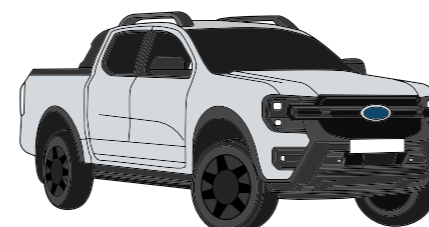

1,25 € par kilomètre
1,25 € per kilometer

Majoration de 25 % à prendre en compte sur certains secteurs géographiques.
A 25% surcharge applies in certain geographic areas.

Les services additionnels

Additional services

[Revenir au sommaire](#)

Return to contents

Pack Brunch Brunch pack

*Ce pack est obligatoire lors d'une seconde journée d'utilisation.
This pack is required from the second day of use.*



-  **La location du véhicule sanitaire pour un second jour d'utilisation.**
The rental of the sanitary vehicle for a second day of use.
-  **Une vidange et un recyclage des eaux usées.**
Wastewater emptying and recycling.
-  **Un nettoyage complet du véhicule pour votre nouvelle journée.**
A full cleaning of the vehicle for your new day of use.
-  **Recharge des consommables.**
Restocking of consumables.

495 €



Autonomie en eau

Water autonomy

-  **Cuve 1000 L eau propre.**
1,000 L clean water tank.
-  **Surpresseur.**
Booster pump.
-  **Transport.**
Transport.

450 €

Tous nos prix sont exprimés en HT. *All prices are quoted excluding VAT.*



Veille hygiène

Hygiene monitoring

-  **Agent d'entretien sur site.**
On-site cleaning attendant.
-  **18h00 - 02h00 (Horaires variables).**
6:00 PM - 2:00 AM (Flexible hours).
-  **Suivi régulier de la propreté des installations.**
Regular monitoring of facility cleanliness.
-  **Recharge des consommables tout au long de l'événement.**
Consumables restocked throughout the event.

400 €



Veille technique

Technical monitoring

-  **Technicien sur site.**
On-site technician.
-  **18h00 - 02h00 (Horaires variables).**
6:00 PM - 02:00 AM (Flexible hours).
-  **Garantir le bon fonctionnement des équipements.**
Ensure proper functioning of all equipment.
-  **Intervention en cas d'incident.**
Immediate intervention in case of any issue.

450 €



À vos côtés
By your side

Nos engagements

Our commitments



I

Respect de l'environnement & de votre bien-être

Environmental commitment & your well-being

*Aucun produit chimique n'est utilisé pour le nettoyage et la désinfection de nos installations.
No chemical products are used in the cleaning and disinfection of our facilities.*

II

Optimisation des déplacements

Route optimization

*Nos installateurs planifient leurs trajets de manière optimale afin de limiter les émissions de CO2.
Our installers carefully plan their travel routes to minimize CO² emissions.*

III

Recyclage et valorisation des effluents

Waste recycling and recovery

*Tous les effluents sont collectés et envoyés dans des stations d'épuration agréées où ils sont recyclés. Notre objectif est de valoriser certaines matières d'ici les trois prochaines années.
All effluents are collected and sent to certified treatment plants where they are properly recycled.
Our goal is to recover certain materials within the next three years.*

IV

Sensibilisation des équipes

Staff awareness

*Nous formons continuellement notre personnel à l'importance des enjeux environnementaux afin de garantir un développement durable du Petit Coin Events dans le secteur de l'événementiel.
We continuously train our teams on environmental issues to ensure the sustainable development of Le Petit Coin Events within the event industry.*

V

Fabrication et conception

Design & manufacturing

*Nous utilisons des matériaux durables et écoresponsables lors de la création et de l'élaboration de nos véhicules dans nos usines françaises.
We use durable, eco-friendly materials in the creation and production of our vehicles, all made in our French workshops.*



Où nous trouver

Where to find us

Légende

Legend



Zones d'intervention principales
Primary service area



Zones d'intervention secondaires (*nous consulter*)
Secondary service area (contact us)

Contactez-nous

Contact us

Service client
Support team

(+33)4 84 47 03 26

contact@lepetitcoin-events.com

lepetitcoin-events.com



Zones d'intervention

Service areas

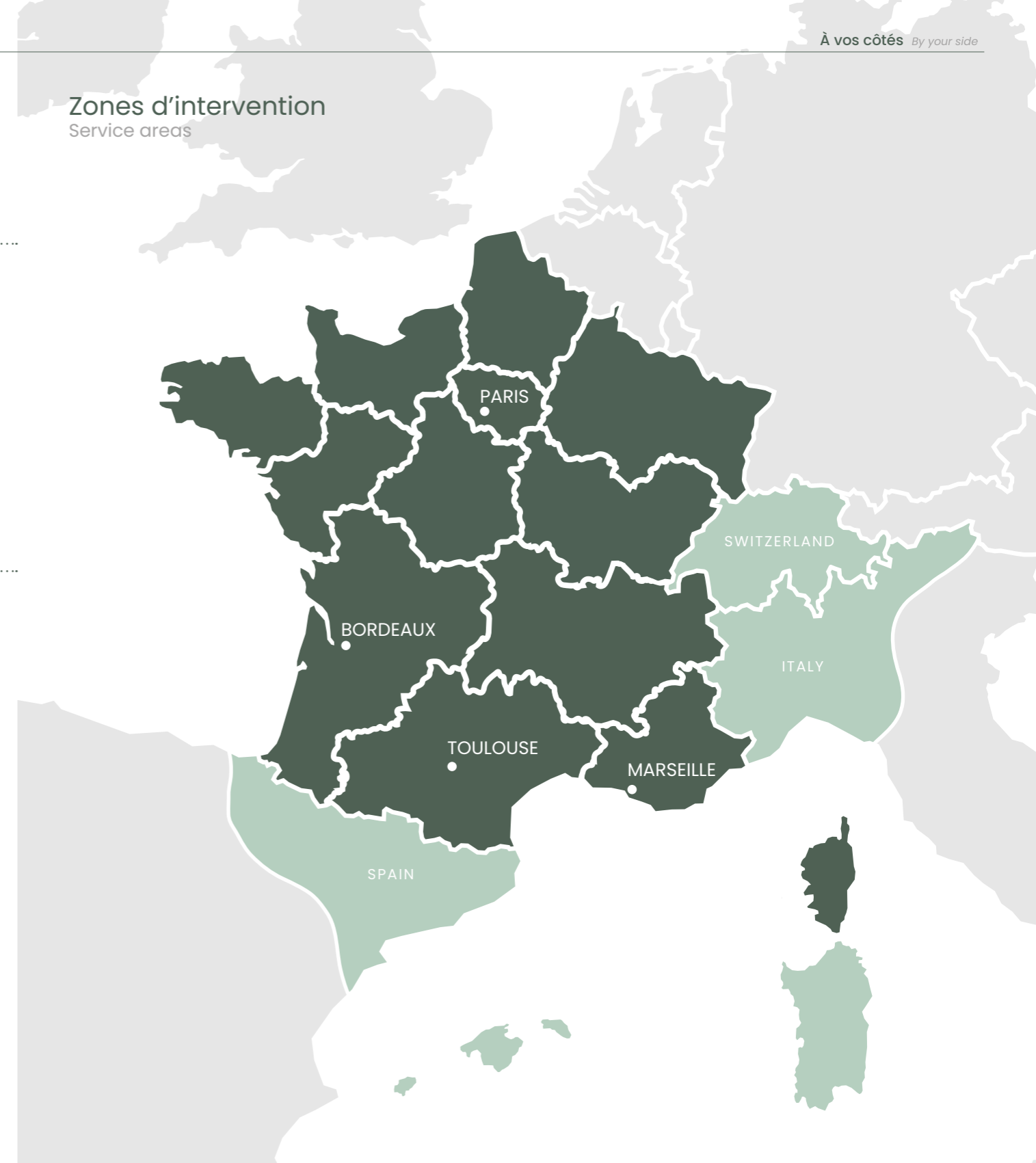



Conception graphique et réalisation : Le Petit Coin Events
Design and production : Le Petit Coin Events

Janvier 2026 – Tous droits réservés.
January 2026 – All rights reserved.



SIÈGE

Marseille · Paris · Toulouse · Bordeaux

(+33)4 84 47 03 26

contact@lepetitcoin-events.com

lepetitcoin-events.com

